

COMPRESSED AIR CATALOGUE 2023



Ing A.F. Baeder Ges.m.b.H.

📍 Kolpingstraße 13, 1230 Vienna

☎ +43 (0)1 865 16 40

✉ sales@baeder-automotive.com

🌐 www.baeder-automotive.com





STEEL-AIR TANKS	01
STEEL-AIR TANKS WITH HOLDER	02
TOWING VEHICLE-SPECIFIC STEEL-AIR TANKS	03
TRAILER-SPECIFIC STEEL-AIR TANKS	04
ALUMINIUM-AIR TANKS	05
TENSION STRAPS FOR AIR TANKS	06
THREAD EXTENSION FOR COUPLING HEADS	07
PLASTIC PIPES PA12	08
AIR BRAKE FITTINGS	10
RELEASABLE FITTINGS	12

EN 286/2

Item nr.	Designation	Dimensions	Connections M22,1,5
1/102	Air tank 1l	102 x 170mm 15,5bar 1,1kg	4
8,5/206	Air tank 8,5l	206 x 315mm 15,5bar 4,5kg	4
10/206	Air tank 10l	206 x 368mm 15,5bar 5,03kg	4
15/206K	Air tank 15l	206 x 520mm 10,0bar 6,8kg	4
15/246	Air tank 15l	246 x 380mm 15,5bar 6,32kg	4
18/276	Air tank 18l	276 x 375mm 15,5bar 7,21kg	4
20/206	Air tank 20l	206 x 685mm 15,5bar 8,28kg	4
20/246	Air tank 20l	246 x 500mm 15,5bar 7,67kg	4
20/276	Air tank 20l	276 x 402mm 15,5bar 7,13kg	4
25/246	Air tank 25l	246 x 610mm 15,5bar 9,72kg	4
30/246	Air tank 30l	246 x 709mm 15,5bar 10,5kg	4
30/276	Air tank 30l	276 x 585mm 15,5bar 10,48kg	4
37/246	Air tank 37l	246 x 864mm 15,5bar 11,5kg	4
40/246	Air tank 40l	246 x 922mm 15,5bar 13,3kg	4
40/276	Air tank 40l	276 x 760mm 15,5bar 13,46kg	4
40/310	Air tank 40l	310 x 620mm 12,5bar 11,0kg	4
60/276	Air tank 60l	276 x 1100mm 12,5bar 16,65kg	4
60/310	Air tank 60l	310 x 891mm 12,5bar 16,05kg	4
60/396	Air tank 60l	396 x 563mm 10,0bar 17,8kg	4
80/310	Air tank 80l	310 x 1157mm 12,5bar 20,12kg	4
80/396	Air tank 30l	396 x 750mm 10,0bar 22,0kg	4
100/396	Air tank 100l	396 x 915mm 10,0bar 25,0kg	4

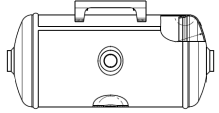
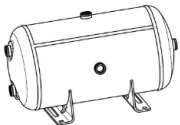
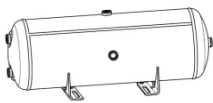
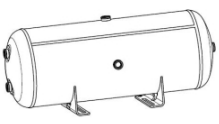
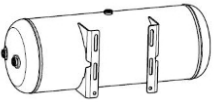

EN 286/2

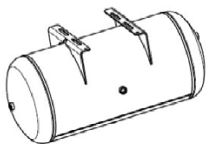
Illustration	Item nr.	Designation	Dimensions	OE reference
	05/154H	Air tank 5l with holder	154 x 345mm 15,5bar 3,87kg	/
	20/246H250	Air tank 20l with holder	246 x 503mm 15,5bar 8,7kg	208 315
	30/246H250	Air tank 30l with holder	246 x 705mm 15,5bar 11,3kg	208 316
	40/276H250	Air tank 40l with holder	276 x 758mm 15,5bar 13,4kg	208 313
	60/310H250	Air tank 60l with holder	310 x 893mm 12,5bar 17,5kg	208 310
	80/396H250	Air tank 80l with holder	396 x 750mm 10,0bar 20,1kg	208 309
	100/396H250	Air tank 100l with holder	396 x 895mm 10,0bar 23,3kg	208 403

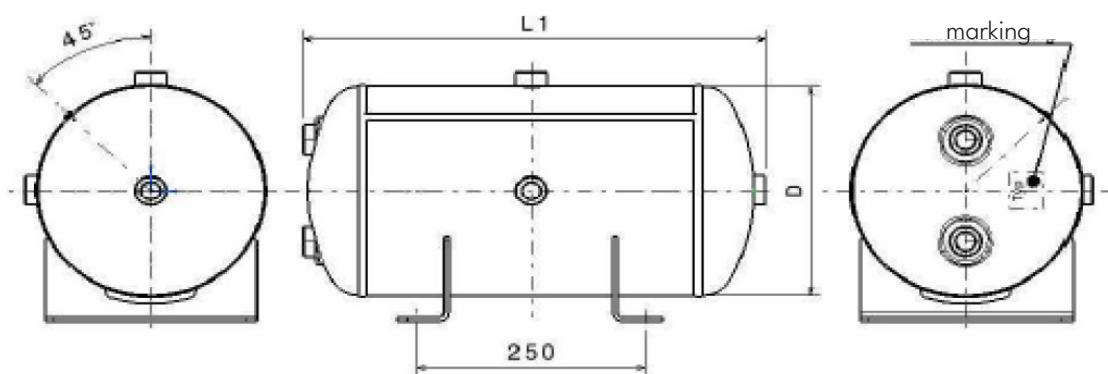







TOWING VEHICLE-SPECIFIC STEEL-AIR TANKS

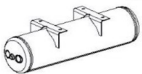

EN 286/2

Illustration	Item nr.	Designation	Dimensions	OE reference	Vehicle
	4/144MB	Air tank 4l	144 x 320mm 15,5bar 2,9kg	A 006 432 3401 A 005 432 3001 A 005 432 1001	Mercedes
	5,4/144MB	Air tank 5,4l	144 x 411mm 15,5bar 3,5kg	A 006 432 3501 A 005 432 3101 A 005 432 1101	Mercedes
	7,5/246MB	Air tank 7,5l	246 x 228mm 15,5bar 4,2kg	A 006 432 4001 A 005 432 3201 A 005 432 1401	Mercedes
	10/206MB	Air tank 10l	206 x 366mm 15,5bar 4,9kg	A 006 432 3701 A 005 432 3301 A 007 432 4101	Mercedes
	20/206MB	Air tank 20l	206 x 677mm 15,5bar 8,5kg	A 006 432 3801 A 005 432 4201 A 007 432 5001	Mercedes
	20/246MB	Air tank 20l	246 x 497mm 15,5bar 7,6kg	A 006 432 4301 A 007 432 4201 A 007 432 4201	Mercedes
	25/246MB	Air tank 25l	246 x 605mm 15,5bar 9,0kg	A 006 432 4401 A 005 432 3801 A 007 432 5401	Mercedes
	25/276MB	Air tank 25l	276 x 495mm 15,5bar 8,5kg	A 006 432 5301 A 005 432 2601 A 007 432 4501	Mercedes
	30/276MB	Air tank 30l	276 x 585mm 15,5bar 9,8kg	A 006 432 5401 A 005 432 2201 A 007 432 4601	Mercedes
	35/276MB	Air tank 35l	276 x 663mm 15,5bar 10,9kg	A 006 432 5601 A 005 432 2701 A 007 432 4801	Mercedes
	45/276MB	Air tank 45l	276 x 844mm 15,5bar 15,8kg	A 006 432 5801 A 005 432 2801 A 005 432 2801	Mercedes
	30/310MAN1	Air tank 30l	310 x 462mm 12,5bar 9kg 6,8kg	81.51401.0180 81.51401.0239 81.51401.6015	MAN
	40/310MAN1	Air tank 40l	310 x 568mm 14,5bar 11kg	81.51401.0182 81.51401.0241 81.51401.6015	MAN
	30/276SCA1	Air tank 30l	276 x 568mm 14,5bar 10,5kg	1357950 488217	Scania

EN 286/2

Illustration	Item nr.	Designation	Dimensions	OE reference	Vehicle
	40/276HSM	Air tank 40l with holder	276 x 760mm 13,5bar 13,1kg	33998	Schwarzmüller
	60/276HSM	Air tank 60l with holder	276 x 1100 12,5bar 17,7kg	33999	Schwarzmüller
	60/396HSM	Air tank 60l with holder	396 x 563mm 12,5bar 17kg	34000	Schwarzmüller
	80/396HSM	Air tank 80l with holder	396 x 750mm 12,5bar 22,5kg	34001	Schwarzmüller
	80/310HS	Air tank 80l with holder	310 x 1157mm 12,5bar 19,9kg	51202	Schmitz
	80/396HS	Air tank 80l with holder	396 x 750mm 12,5bar 22,5kg	1009330	Schmitz
	80/396HS2	Air tank 80l with holder	396 x 750mm 10bar 22,5kg	1153350	Schmitz
	80/396HS3	Air tank 80l with holder	396 x 750mm 10bar 22,5kg	1219118	Schmitz

EN 286/2

Item nr.	Designation	Dimensions	Connections M22,1,5
10/206A	Air tank 10l without holder (1)	206 x 375mm 12,5bar 2,3kg	4
20/206A	Air tank 20l without holder (1)	206 x 694mm 12,5bar 4,0kg	4
20/246A	Air tank 20l without holder (1)	246 x 500mm 12,5bar 3,5kg	4
30/246A	Air tank 30l without holder (1)	246 x 720mm 12,5bar 4,9kg	4
40/246A	Air tank 40l without holder (1)	246 x 942mm 12,5bar 6,2kg	4
40/276A	Air tank 40l without holder (1)	276 x 766mm 12,5bar 5,9kg	4
60/276A	Air tank 60l without holder (1)	276 x 1116mm 12,5bar 8,4kg	4
60/310A	Air tank 60l without holder (1)	310 x 907mm 11,0bar 7,8kg	4
60/396A	Air tank 60l without holder (1)	396 x 590mm 11,0bar 8,3kg	4
80/310A	Air tank 80l without holder (1)	310 x 1183mm 11,0bar 10kg	4
80/396A	Air tank 80l without holder (1)	396 x 761mm 11,0bar 10,1kg	4
05/154AH	Air tank 5l with holder (2)	154 x 350mm 12,5bar 1,7kg	3
20/206AH	Air tank 20l with holder (2)	206 x 694mm 12,5bar 4,0kg	4
30/246AH	Air tank 30l with holder (2)	246 x 720mm 12,5bar 5,1kg	4
30/276AH	Air tank 30l with holder (2)	276 x 591mm 12,5bar 4,9kg	4
40/276AH	Air tank 40l with holder (2)	276 x 766mm 12,5bar 6,1kg	4
60/276AH	Air tank 60l with holder (2)	276 x 1116mm 12,5bar 8,4kg	4
60/310AH	Air tank 60l with holder (2)	310 x 907mm 11,0bar 7,9kg	4
60/396AH	Air tank 60l with holder (2)	396 x 590mm 11,0bar 8,3kg	4
80/396AH	Air tank 80l with holder (2)	396 x 761mm 11,0bar 10,1kg	4
100/396AH	Air tank 100l with holder (2)	396 x 930mm 10,0bar 12,1kg	4
60/310AHR	Air tank 60l with holder (3)	310 x 879mm 11,0bar 8,7kg	4
60/396AHR	Air tank 60l with holder (3)	396 x 583mm 11,0bar 8,8kg	4
80/396AHR	Air tank 80l with holder (3)	396 x 748mm 11,0bar 11,0kg	4

without holder (1)

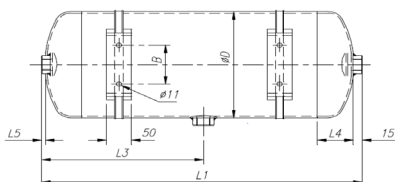

with holder (2)

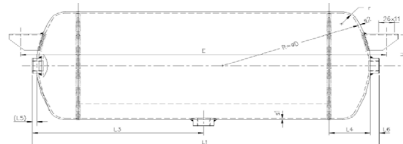

with holder (3)

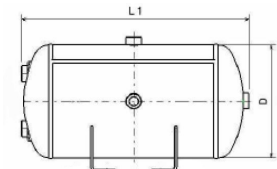

SINGLE PIECE

Item nr.	Designation
030 2001 09	Tension strap 206mm
030 2002 09	Tension strap 246mm
030 2003 09	Tension strap 276mm
030 2004 09	Tension strap 310mm
030 2006 09	Tension strap 396mm

FEATURES

- combines advantages of one-piece and two-piece tension straps
- easy assembly
- high quality paint



VS1001

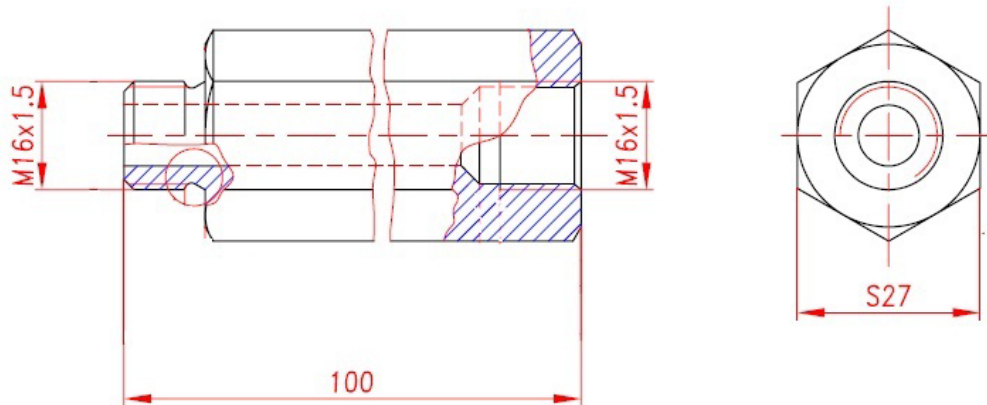

ADVANTAGES

- no kinking of the brake hose
- good operability

WRAPPED AT 100M; AVAILABLE IN MANY COLOURS

Itemnr.	Role	Ø Diameter	Colour	DIN
KR112 6x1 S100	100 m	6 x 1	black	74324
KR114 6x1 R100			red	73378
KR115 6x1 Y100			yellow	73378
KR116 6x1 G100			green	73378
KR117 6x1 B100			blue	73378
KR122 8x1 S100		8 x 1	black	74324
KR124 8x1 R100			red	73378
KR125 8x1 Y100			yellow	73378
KR126 8x1 G100			green	73378
KR127 8x1 B100			blue	73378
KR132 10x1 S100		10 x 1	black	74324
KR134 10 x1 R100			red	73378
KR173 10x1,25 S100		10 x 1,25	black	74324
KR174 10x1,25 R100			red	73378
KR175 10x1,25 Y100			yellow	73378
KR142 12x1,5 S100		12 x 1,5	black	74324
KR144 12x1,5 R100			red	73378
KR152 15x1,5 S100		15 x 1,5	black	74324
KR182 16x2 S100		16 x 2	black	74324
KR163 18x2 S100		18 x 2	black	74324



WRAPPED AT 25M

Itemnr.	Role	Ø Diameter	Colour	DIN
KR111 6x1 S25	25 m	6 x 1	black	74324
KR121 8x1 S25		8 x 1		
KR131 10x1 S25		10 x 1		
KR141 12x1,5 S25		12 x 1,5		
KR151 15x1,5 S25		15 x 1,5		
KR161 18x2 S25		18 x 2		

ON DRUM IN BLACK

Itemnr.	Role	Ø Diameter	Colour	DIN
KR113 6x1 S1.000	1000 m	6 x 1	black	74324
KR123 8x1 S800	800 m	8 x 1		
KR133 10x1 S500	500 m	10 x 1		
KR143 12x1,5 S350	350 m	12 x 1,5		
KR153 15x1,5 S200	200 m	15 x 1,5		

features of drum:

- disposable wooden drum
- decent twist-free rolling
- high quality material
- roll length see above
- dimensions:
 - diameter: 600mm
 - width: 300mm
 - hole: 60mm



BRAKE HOSES

brake hose 13x25
065 0001 09.



coil of 40m, DIN74310

brake hose 11x18
065 0010 09



coil of 50m, DIN74310

Push-in fittings non-detachable



Ø	M 12 x 1,5	M 16 x 1,5	M 22 x 1,5
6 x 1	301 0612 5	301 0616 2	301 0622 2
8 x 1	301 0812 5	301 0816 5	301 0822 5
9 x 1,5		301 0916 2	301 0922 2
10 x 1	301 1012 5	301 1016 5	301 1022 5
10 x 1,25	301 0212 2	301 0216 5	301 0222 2
11 x 1,5		301 1116 2	301 1122 2
12 x 1,5	301 1212 2	301 1216 5	301 1222 5
15 x 1,5		301 1516 5	301 1522 5
16 x 2		301 1616 2	301 1622 2
18 x 2			301 1822 5

Straight stud coupling



Ø	M 12 x 1,5	M 16 x 1,5	M 22 x 1,5
6 x 1	401 0612 2	401 0616 2	401 0622 2
8 x 1	401 0812 2	401 0816 2	401 0822 2
10 x 1	401 1012 2	401 1016 2	401 1022 2
12 x 1,5	401 1212 2		401 1222 2
15 x 1,5		401 1517 2	101 1522 2
18 x 2			101 1822 2

Straight fitting push-in



D1	D2	Item nr.
6 x 1	6 x 1	303 0606 5
8 x 1	6 x 1	303 0806 2
8 x 1	8 x 1	303 0808 5
9 x 1,5	9 x 1,5	303 0909 5
10 x 1	8 x 1	303 1008 2
10 x 1	10 x 1	303 1010 5
11 x 1,5	11 x 1,5	303 1111 2
12 x 1,5	8 x 1	303 1208 2
12 x 1,5	10 x 1	303 1210 2
12 x 1,5	12 x 1,5	303 1212 5
15 x 1,5	15 x 1,5	303 1515 5
16 x 2	16 x 2	303 1616 2
18 x 2	18 x 2	303 1818 2

Straight fitting



D1	D2	Item nr.
6 x 1	6 x 1	403 0606 2
8 x 1	6 x 1	103 0806 2
8 x 1	8 x 1	103 0808 2
10 x 1	6 x 1	103 1006 2
10 x 1	8 x 1	103 1008 2
10 x 1	10 x 1	103 1010 2
12 x 1,5	6 x 1	103 1206 2
12 x 1,5	8 x 1	103 1208 2
12 x 1,5	10 x 1	103 1210 2
12 x 1,5	12 x 1,5	103 1212 2
15 x 1,5	10 x 1	103 1510 2
15 x 1,5	12 x 1,5	103 1512 2
15 x 1,5	15 x 1,5	103 1515 2
18 x 2	15 x 1,5	103 1815 2
18 x 2	18 x 2	103 1818 2

Stud elbow coupling



Ø	M 16 x 1,5	M 22 x 1,5
8 x 1	405 0816 2	405 0822 2
10 x 1	405 1016 2	405 1022 2
12 x 1,5	405 1216 2	405 1222 2

Stud elbow coupling push-in



Ø	M 12 x 1,5	M 16 x 1,5	M 22 x 1,5
6 x 1	305 0612 2	305 0616 2	305 0622 2
8 x 1	305 0812 2	305 0816 2	305 0822 2
10 x 1	305 1012 2	305 1016 2	305 1022 2
10 x 1,25	305 0212 2	305 0216 2	305 0222 2
12 x 1,5		305 1216 2	305 1222 2
15 x 1,5		305 1516 2	305 1522 2
18 x 2			305 1822 2

Bulkhead elbow couplings

Ø	Thread	Item nr.
R12 x 1,5	M16 x 1,5 (R10 x 1)	316 1290 2
R12 x 1,5	M18 x 1,5 (R12 x 1,5)	316 1296 2
R15 x 1,5	M22 x 1,5 (R15 x 1,5)	316 1596 2

Hosetails



Thread	S 11	S 13
M16 x 1,5 without o-ring	950 1116 2	950 1316 2
M16 x 1,5 with o-ring	850 1116 5.	850 1316 5.
M22 x 1,5 without o-ring	950 1122 2	950 1322 2
M22 x 1,5 with o-ring	850 1122 5.	850 1322 5.

Hosetails pre-assembled



Ø	Thread	S 11	S 13
R12 x 1,5		952 1112 2	
R10 x 1	M16 x 1,5	452 1110 2	
R12 x 1,5	M18 x 1,5	452 1112 2	452 1312 2
R15 x 1,5	M22 x 1,5	452 1115 2	452 1315 2

Hosetails connectors



Ø	S 11	S 13
R10 x 1	351 1110 2	
R12 x 1,5	351 1112 2	351 1312 2
R15 x 1,5	351 1115 2	351 1315 2

Reducer (with o-ring)



G1	G2	Item nr.
M12 x 1,5	M16 x 1,5	361 1612 5.
M12 x 1,5	M22 x 1,5	361 2212 5.
M14 x 1,5	M22 x 1,5	361 2214 2
M16 x 1,5	M22 x 1,5	361 2216 5.

Sleeve

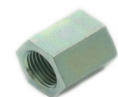

Thread	Item nr.
M12 x 1,5	460 1225 2
M14 x 1,5	460 1425 2
M16 x 1,5	460 1625 2
M18 x 1,5	460 1825 2
M22 x 1,5 short 25mm	460 2225 2
M22 x 1,5 long 38mm	460 2238 2

Blanking plug (with o-ring)



Thread	Item nr.
M12 x 1,5	362 0012 5.
M16 x 1,5	362 0016 5.
M22 x 1,5	362 0022 5.

Blanking plug (without o-ring)



Gewinde	Art.-Nr.
M10 x 1	462 0010 2
M12 x 1,5	462 0012 2
M14 x 1,5	462 0014 2
M16 x 1,5	462 0016 2
M22 x 1,5	462 0022 2
M22 x 1,5	462 0522 2

Test Points



Ø	Art.-Nr.
12 x 1,5 without o-ring	465 1112 2
16 x 1,5 with o-ring	365 0916 5.
16 x 1,5 without o-ring	465 0916 5
22 x 1,5 with o-ring	365 0922 5.
22 x 1,5 without o-ring	465 0922 5



Drain valve



Description	M 22 x 1,5
with ring, with o-ring	366 1122 5
without ring, with o-ring	366 1222 5.
with ring, without o-ring	466 1122 5



Hexagon nut



Thread	Item nr.
M12 x 1,5	1D064
M14 x 1,5	677 0014 2
M16 x 1,5	677 0016 2
M18 x 1,5	677 0018 2
M22 x 1,5	977 0022 2
M26 x 1,5	977 0026 2

Push-in unit



Ø	M 14 x 1,5	M 16 x 1,5	M 18 x 1,5	M 22 x 1,5
8 x 1	370 0810 5		370 2810 5	
9 x 1,5		370 0915 5		
10 x 1		370 1010 5	370 2010 5	
10 x 1,25		370 1012 5		
10 x 1,5		370 1015 5		
11 x 1,5			370 1115 5	
12 x 1,5			370 1215 5	
15 x 1,5				370 1515 5
15 x 2				370 1520 5
16 x 2				370 1620 5

Coupling nut & compression ring



Item nr.	Thread	Ø	Item nr.
670 0006 2	M12 x 1,5	6 x 1	671 0006 2
670 0008 2	M14 x 1,5	8 x 1	671 0008 2
670 0010 2	M16 x 1,5	10 x 1	671 0010 2
670 0012 2	M18 x 1,5	12 x 1,5	671 0012 2
670 0015 2	M22 x 1,5	15 x 1,5	671 0015 2
670 0018 2	M26 x 1,5	18 x 2	671 0018 2



O-Ring & Druckring



Item nr.	for thread	Item nr.
979 0012 9	M12 x 1,5	978 0012 5
979 0014 9	M14 x 1,5	978 0014 5
979 0016 9	M16 x 1,5	978 0016 5
979 0018 9	M18 x 1,5	978 0018 5
979 0022 9	M22 x 1,5	978 0022 5
979 0026 9	M26 x 1,5	978 0026 5



Tubular stiffener



Ø	Ø for tube	Item nr.
4 mm	6 x 1	982 0610 5
6 mm	8 x 1	982 0810 5
7 mm	10 x 1,5	982 1015 5
8 mm	10 x 1	982 1010 5
9 mm	12 x 1,5	982 1215 5
12 mm	15 x 1,5	982 1515 5
14 mm	18 x 2	982 1820 5

Pipe clamp



Ø	Item nr.
6 mm	487 0006 2
8 mm	487 0008 2
10 mm	487 0010 2
12 mm	487 0012 2
15 mm	487 0015 2
18 mm	487 0018 2

Hose clamp



Ø	Item nr.
18mm (S11)	488 1812 2
25mm (S13)	488 2515 2

Stud elbow couplings



G1	G2	Item nr.
M12 x 1,5	M16 x 1,5	805 1215 5.
M16 x 1,5	M16 x 1,5	805 1615 5.
M16 x 1,5	M22 x 1,5	805 2215 5.
M22 x 1,5	M22 x 1,5	805 2221 5.

Barrel tees



G1	G2	Art.-Nr.
M12 x 1,5	M12 x 1,5	808 1211 5.
M12 x 1,5	M16 x 1,5	808 1611 5.
M16 x 1,5	M16 x 1,5	808 1615 5.
M16 x 1,5	M22 x 1,5	808 2215 5.

Branch tees



G1	G2	Art.-Nr.
M16 x 1,5	M16 x 1,5	810 1615 5.
M16 x 1,5	M22 x 1,5	810 2215 5.

Barrel tee couplings



Gewinde	Art.-Nr.
M16 x 1,5	308 1615 5.
M22 x 1,5	308 2221 5.

Double connectors



G1	G2	G3	Art.-Nr.
M16 x 1,5	M16 x 1,5	M22 x 1,5	314 9616 5
M16 x 1,5	M22 x 1,5	M22 x 1,5	314 9622 5

more information



Straight stud couplings

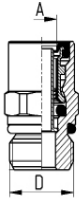

D	A	Item nr.
M10 x 1,5	6 x 1	VSC1124 9512
M12 x 1,5	6 x 1	VSC1125 9512
M14 x 1,5	6 x 1	VSC1126 9512
M16 x 1,5	6 x 1	VSC1123 9512
M22 x 1,5	6 x 1	VSC1127 9512
M10 x 1	8 x 1	VSC1129 9512
M12 x 1,5	8 x 1	VSC1130 9512
M14 x 1,5	8 x 1	VSC1132 9512
M16 x 1,5	8 x 1	VSC1128 9512
M22 x 1,5	8 x 1	VSC1131 9512
M12 x 1,5	10 x 1	VSC1135 9512
M16 x 1,5	10 x 1	VSC1133 9512
M22 x 1,5	10 x 1	VSC1138 9512
M12 x 1,5	12 x 1,5	VSC1141 9512
M14 x 1,5	12 x 1,5	VSC1143 9512
M16 x 1,5	12 x 1,5	VSC1140 9512
M22 x 1,5	12 x 1,5	VSC1142 9512
M16 x 1,5	15 x 1,5	VSC1145 9512
M22 x 1,5	15 x 1,5	VSC1147 9512
M16 x 1,5	16 x 2	VSC1148 9512
M22 x 1,5	16 x 2	VSC1150 9512
M22 x 1,5	18 x 2	VSC1151 9512

Straight connectors

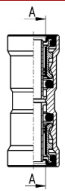

A	Item nr.
6 x 1	VSC1163 9580
8 x 1	VSC1164 9580
10 x 1	VSC1165 9580
12 x 1,5	VSC1168 9580
15 x 1,5	VSC1171 9580
16 x 2	VSC1172 9580
18 x 2	VSC1173 9580

Branch tee couplings

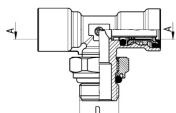

D	A	Item nr.
M12 x 1,5	6 x 1	VSC1056 9412
M16 x 1,5	6 x 1	VSC1054 9412
M22 x 1,5	6 x 1	VSC1057 9412
M12 x 1,5	8 x 1	VSC1059 9412
M16 x 1,5	8 x 1	VSC1058 9412
M22 x 1,5	8 x 1	VSC1060 9412
M12 x 1,5	10 x 1	VSC1064 9412
M16 x 1,5	10 x 1	VSC1062 9412
M22 x 1,5	10 x 1	VSC1066 9412
M16 x 1,5	12 x 1,5	VSC1067 9412
M22 x 1,5	12 x 1,5	VSC1069 9412
M16 x 1,5	15 x 1,5	VSC1070 9412
M22 x 1,5	15 x 1,5	VSC1072 9412

T screw-in sockets

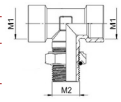

M1	M2	Item nr.
M16 x 1,5	M12 x 1,5	810 1215 5.
M16 x 1,5	M16 x 1,5	810 1615 5.
M16 x 1,5	M22 x 1,5	VSC1014 D2062
M16 x 1,5	M22 x 1,5	810 2215 5.

Barrel tee couplings

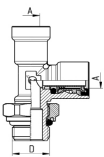

D	A	Item nr.
M10 x 1	6 x 1	VSC1075 9422
M12 x 1,5	6 x 1	VSC1076 9422
M16 x 1,5	6 x 1	VSC1074 9422
M12 x 1,5	8 x 1	VSC1078 9422
M16 x 1,5	8 x 1	VSC1077 9422
M22 x 1,5	8 x 1	VSC1079 9422
M16 x 1,5	10 x 1	VSC1080 9422
M22 x 1,5	10 x 1	VSC1081 9422
M16 x 1,5	12 x 1,5	VSC1082 9422
M22 x 1,5	12 x 1,5	VSC1084 9422
M16 x 1,5	15 x 1,5	VSC1085 9422
M22 x 1,5	15 x 1,5	VSC1072 9422

Barrel tees

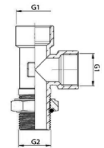

G2	G1	Item nr.
M12 x 1,5	M12 x 1,5	808 1211 5.
M16 x 1,5	M12 x 1,5	808 1611 5.
M16 x 1,5	M16 x 1,5	808 1615 5.
M16 x 1,5	M16 x 1,5	VSC1018 D2072
M22 x 1,5	M16 x 1,5	808 2215 5.
M22 x 1,5	M22 x 1,5	808 2221 5.

Y screw connections



D	A	Item nr.
M16 x 1,5	8 x 1	VSC1092 9450
M16 x 1,5	12 x 1,5	VSC1093 9450
M22 x 1,5	12 x 1,5	VSC1094 9450

F screw connections



D	A	Item nr.
M16 x 1,5	12 x 1,5	VSC1052 9402
M22 x 1,5	12 x 1,5	VSC1053 9402

Corner screw-in sockets

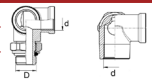

D	d	Item nr.
M16 x 1,5	M16 x 1,5	VSC1022 D2077
M22 x 1,5	M16 x 1,5	VSC1023 D2077

Stud elbow couplings

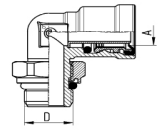

D	A	Item nr.
M10 x 1	6 x 1	VSC1098 9502
M12 x 1,5	6 x 1	VSC1099 9502
M16 x 1,5	6 x 1	VSC1097 9502
M22 x 1,5	6 x 1	VSC1100 9502
M12 x 1,5	8 x 1	VSC1103 9502
M14 x 1,5	8 x 1	VSC1105 9502
M16 x 1,5	8 x 1	VSC1101 9502
M22 x 1,5	8 x 1	VSC1104 9502
M12 x 1,5	10 x 1	VSC1109 9502
M16 x 1,5	10 x 1	VSC1107 9502
M22 x 1,5	10 x 1	VSC1111 9502
M12 x 1,5	12 x 1,5	VSC1114 9502
M16 x 1,5	12 x 1,5	VSC1113 9502
M22 x 1,5	12 x 1,5	VSC1115 9502
M16 x 1,5	15 x 1,5	VSC1117 9502
M22 x 1,5	15 x 1,5	VSC1118 9502
M22 x 1,5	16 x 2	VSC1121 9502
M22 x 1,5	18 x 2	VSC1122 9502

Elbow screw-in sockets



G2 G1

G1	G2	Item nr.
M16 x 1,5	M12 x 1,5	805 1215 5.
M16 x 1,5	M16 x 1,5	805 1615 5.
M22 x 1,5	M16 x 1,5	VSC1008 D2022
M22 x 1,5	M16 x 1,5	805 2215 5.
M22 x 1,5	M22 x 1,5	805 2221 5.

Cross screws



D	d	Item nr.
M16 x 1,5	M16 x 1,5	VSC1013 D2032
M22 x 1,5	M16 x 1,5	VSC1012 D2032

Bulkhead connectors



D	A	B	Item nr.
M16 x 1,5	8	10	VSC1199 9590
M18 x 1,5	12	12	VSC1198 9590

Double connectors



G1	G2	G3	Item nr.
M16 x 1,5	M16 x 1,5	M22 x 1,5	314 9616 5
M16 x 1,5	M22 x 1,5	M22 x 1,5	314 9622 5

RELEASABLE FITTINGS



Bulkhead connectors

D	A	B	Item nr.
M18 x 1,5	6 x 1	6 x 1	VSC1202 9592
M18 x 1,5	8 x 1	8 x 1	VSC1178 9592
M18 x 1,5	12 x 1,5	8 x 1	VSC1179 9592
M24 x 1,5	12 x 1,5	12 x 1,5	VSC1203 9592
M28 x 1,5	15 x 1,5	15 x 1,5	VSC1204 9592

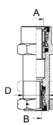

Branch tee couplings

A	A1	Item nr.
6 x 1	6 x 1	VSC1155 9540
8 x 1	8 x 1	VSC1156 9540
10 x 1	10 x 1	VSC1158 9540
12 x 1,5	12 x 1,5	VSC1159 9540

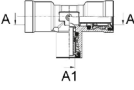

Barrel tee couplings

Thread	Item nr.
M16 x 1,5	308 1615 5.
M22 x 1,5	308 2221 5.



5-fold distributor

d	Item nr.
M16 x 1,5	VSC1190 D3043



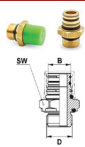
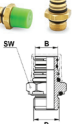

Plug-in units c-truck

B	D	Remark	Item nr.
C1	M10 x 1		VSC1045 D2912
C1	M12 x 1,5		VSC1046 D2912
C1	M14 x 1,5		VSC1049 D2912
C1	M16 x 1,5	SW22	VSC1043 D2912
C1	M22 x 1,5		VSC1047 D2912



Bulkhead connectors c-truck

B	D	D1	Item nr.
C1	M22 x 1,5	M16 x 1,5	VSC1191 D2993

Bulkhead swivel connectors

D	A	B	Item nr.
M20 x 1,5	8 x 1	C1	VSC1200 9919
M24 x 1,5	12 x 1,5	C1	VSC1201 9919

Elbow screw c-truck

d	A	B	Item nr.
M16 x 1,5		C1	VSC1024 D2220
M12 x 1,5		C1	VSC1025 D2220
	6 x 1	C1	VSC1185 9520
	8 x 1	C1	VSC1152 9520
	10 x 1	C1	VSC1184 9520
	12 x 1,5	C1	VSC1153 9520
	15 x 1,5	C1	VSC1154 9520
	16 x 2	C1	VSC1192 9520
M16 x 1,5		C1	VSC1189 D2210

L-piece c-truck

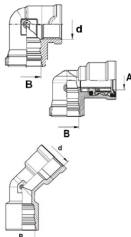
d	A	B	Item nr.
M16 x 1,5		C1	VSC1028 D2270
M12 x 1,5		C1	VSC1029 D2270
	6 x 1	C1	VSC1187 9440
	8 x 1	C1	VSC1089 9440
	10 x 1	C1	VSC1182 9440
	12 x 1,5	C1	VSC1090 9440
	15 x 1,5	C1	VSC1091 9440

Tee c-truck

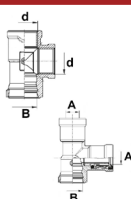
d	A	B	Item nr.
M16 x 1,5		C1	VSC1026 D2260
M12 x 1,5		C1	VSC1027 D2260
	6 x 1	C1	VSC1186 9430
	8 x 1	C1	VSC1086 9430
	10 x 1	C1	VSC1183 9430
	12 x 1,5	C1	VSC1087 9430
	15 x 1,5	C1	VSC1088 9430

Anti-rotation ring

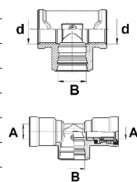
Remark	Item nr.
SW 22	VSC1180 9707
SW 24	VSC1181 9707



Pipe release tool

Description	Item nr.
Pipe release tool 6	VSC1001 DRK6
Pipe release tool 8	VSC1002 DRK8
Pipe release tool 10	VSC1003 DRK10
Pipe release tool 12	VSC1004 DRK12
Pipe release tool 15	VSC1005 DRK15
Pipe release tool 16	VSC1006 DRK16
Pipe release tool 18	VSC1007 DRK18



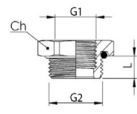

Thread adapters (with seal)

G2	G1	Item nr.
M16 x 1,5	M12 x 1,5	361 1612 5.
M22 x 1,5	M12 x 1,5	361 2212 5.
M22 x 1,5	M14 x 1,5	361 2214 2.
M22 x 1,5	M16 x 1,5	361 2216 5.

Lock screw

Thread	V	Item nr.
Thread version 1 (V1)	M10 x 1	2 362 0010 2
		1 VSC1193 D2612
Thread version 2 (V2)	M12 x 1,5	2 362 0012 5.
	M14 x 1,5	2 462 0014 2
picture: version 3 (V3)	M16 x 1,5	1 VSC1194 D2612
		2 362 0016 5.
picture: version 4 (V4)		3 362 8016 2
	M22 x 1,5	1 VSC1195 D2612
		2 362 0022 5.
		3 362 8022 2
		4 462 0522 2

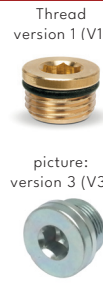

Screw-in test port

Ø	Item nr.
16 x 1,5 with seal	365 0916 5.
22 x 1,5 with seal	365 0922 5.



Drain valve

Description M 22 x 1,5	Item nr.
with ring, with seal	366 1122 5
with ring, without seal	466 1122 5

Hosetail with seal

Thread version 2 (V2)	S	G	V	Item nr.
	11	M16 x 1,5	2	850 1116 5.
	11	M22 x 1,5	2	850 1122 5.
	13	M16 x 1,5	2	850 1316 5.
	13	M22 x 1,5	2	850 1322 5.



more information

